

FITTING INSTRUCTION

Clamp mark in acc. with		Cables joining
ISO	PN	
1	L	Left directional lights
2	+	Rear fog lights
3	31	Ground
4	R	Right directional lights
5	58R	Right side parking lights
6	54	Stoplights
7	58L	Left side parking lights

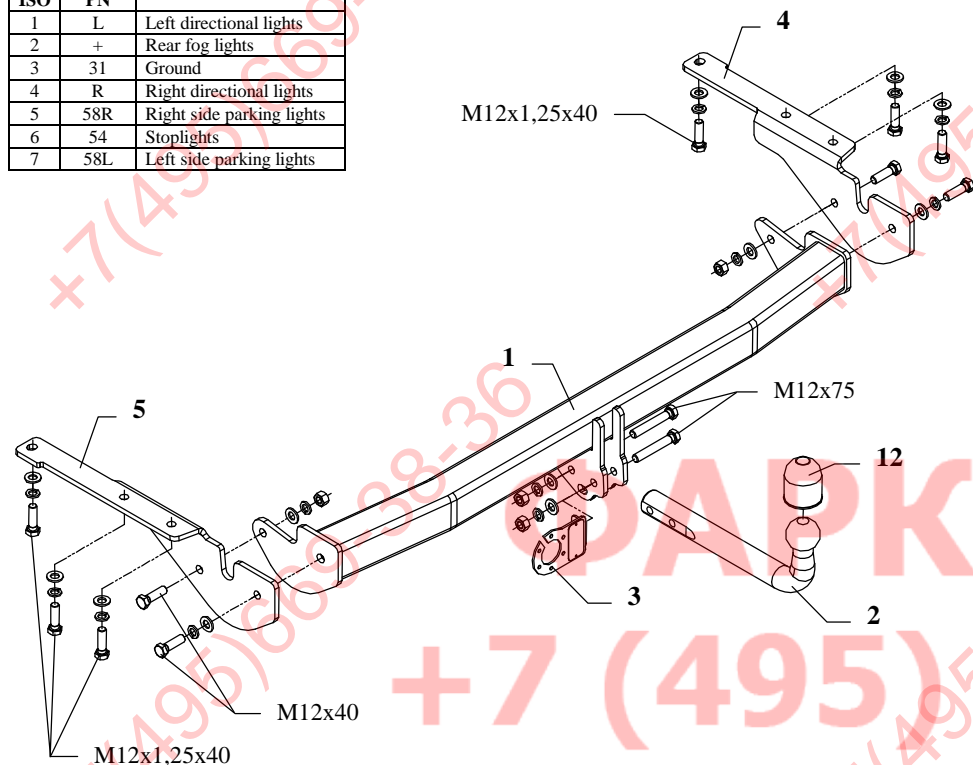

This towbar is designed to assembly in following cars:
TOYOTA RAV-4 “X”, model without the spare wheel, produced since 2005, catalogue no. **O66** and is prepared to tow trailers max total weight **2000 kg** and max vertical load **75 kg**.

From manufacturer

Thank you for buying our product. Their reliability has been confirmed in many tests. Reliability of towbar depends also on correct assembly and right operation. For this reasons we kindly ask to read carefully this instruction and apply to hints.

The towbar should be install in points described by a car producer.

The instruction of the assembly

1. For the purpose of installing of the towbar it is not necessary to disassemble the bumper.
2. From the bottom of chassis members are factory-made assembly holes. One ought to fix to them side brackets of the towbar (pos. 4 and 5) using bolts M12x1,25x40mm (pos. 8) – loosely.
3. Slip the main bar of the towbar (pos. 1) between brackets (pos. 4 and 5) and fix using bolts M12x40mm.
4. Fix tow-ball (pos. 2) with socket plate (pos. 3) using bolts M12x75mm (pos. 6) from accessories.
5. Tighten all bolts according to the torque shown in the table.
6. Connect electric wires of 7-poles socket according to the instruction of the car. (Recommend to make at authorized service station).
7. Complete paint layer damaged during installation.

Torque settings for nuts and bolts (8,8):	
M 8 - 25 Nm	M 10 - 55 Nm
M 12 - 85 Nm	M 14 - 135 Nm



NOTE

After install the towbar you should get adequate note in registration book (at authorised service station).The car should be equipped with:

- Indicators
- Tow mirrors

After 1000km check all bolts and nuts. The ball of towbar must be always kept clear and conserve with a grease.

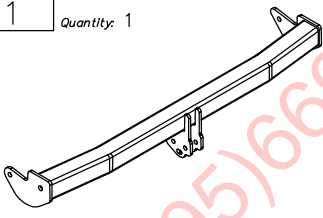
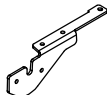
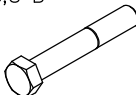
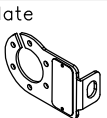
Towbar accessories:

Pos. 1 Name: Main bar Quantity: 1	Pos. 4 Name: Right side bracket Quantity: 1	Pos. 8 Name: Bolt 8,8 B Quantity: 6 Dim.: M12x1,25x40mm
	Pos. 5 Name: Left side bracket Quantity: 1	Pos. 9 Name: Nut 8 B Quantity: 4 Dim.: M12
	Pos. 6 Name: Bolt 8,8 B Quantity: 2 Dim.: M12x75mm	Pos. 10 Name: Plain washer Quantity: 12 Dim.: Ø 13 mm
Pos. 2 Name: Tow ball Quantity: 1		Pos. 11 Name: Spring washer Quantity: 12 Dim.: Ø 12,2 mm
Pos. 3 Name: Socket plate Quantity: 1	Pos. 7 Name: Bolt 8,8 B Quantity: 4 Dim.: M12x40mm	Pos. 12 Name: Ball cover Quantity: 1
		



PPUH AUTO-HAK S.J.

Produkcja Haków Holowniczych
Henryk & Zbigniew Nejman
76-200 SŁUPSK ul. Stoneczna 16K
tel/fax (059) 8-414-414; 8-414-413
E-mail: office@autohak.com.pl
www.autohak.com.pl

Towing hitch (without electrical set)

Class: **A50-X** Cat. no. **O66**

Designed for:

Manufacturer: **TOYOTA**

Model: **RAV-4 "X"**

model without the spare wheel

produced since 2005

Technical data:

D-value: 10,25 kN

maximum trailer weight: **2000 kg**

maximum vertical cup load: **75 kg**

Approval number according to Directive 94/20/EC: **e20*94/20*0073*00**

Foreword

This towbar is designed according to rules of safety traffic regulations. The towing hitch is a safety component and can be install only by qualified personnel. Any alteration or conversion of the towing hitch is prohibited and would lead to cancellation of design certification. Remove insulating compound and underseal from vehicle (if present) in the area of the matting surfaces of the towing hitch. The vehicle manufacturer's specifications regarding trailer load and max. vertical cup load are decisive for driving whereat values for the towing hitch cannot be exceeded.

D-value formula:

$$\frac{\text{Max trailer weight [kg]} \times \text{Max vehicle weight [kg]}}{\text{Max trailer weight [kg]} + \text{Max vehicle weight [kg]}} \times \frac{9,81}{1000} = D \text{ [kN]}$$